



ALAMO INDUSTRIAL

PO BOX 549
SEGUIN TX 78156-9967

Please fold (do not tear), tape, and drop in any mailbox.

**PLEASE FILL OUT OWNER WARRANTY REGISTRATION INFORMATION
SIGN, AND DROP LAST COPY IN ANY MAILBOX.**

**IMPORTANT!
TO PLACE THIS WARRANTY IN EFFECT,
THIS WARRANTY REGISTRATION MUST BE
FILLED OUT, SIGNED, AND MAILED WITHIN 30
DAYS OF DELIVERY DATE OF THIS MACHINE.
DEALER AND PURCHASER MUST SIGN.**

**ATTENTION: ANY CLAIM SUBMITTED TO ALAMO INDUSTRIAL®
WILL BE REFUSED UNTIL COMPLETED, SIGNED
WARRANTY REGISTRATION CARD IS ON FILE.**



BlowGun™

DEBRIS BLOWER

Published 01/99

Effective S/N 010001 - Current

Part No. 02974482



OPERATOR'S MANUAL with PARTS LISTING

ALAMO INDUSTRIAL

1502 E. Walnut
Seguin, Texas 78155
830-372-3080

An Alamo Group Company







© 2000 Alamo Group Inc.

TO THE OWNER/OPERATOR/DEALER

All implements with moving parts are potentially hazardous. There is no substitute for a cautious, safe-minded operator who recognizes the potential hazards and follows reasonable safety practices. The manufacturer has designed this implement to be used with all its safety equipment properly attached to minimize the chance of accidents.

BEFORE YOU START!!

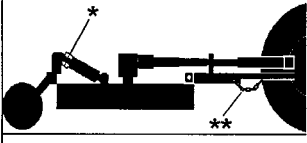
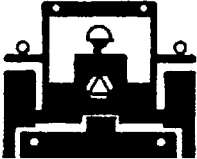
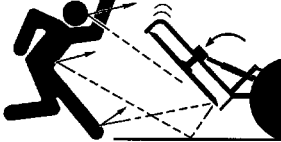
Read the safety messages on the implement and shown in your manual. Observe the rules of safety and common sense!

 <h1 style="display: inline; margin-left: 20px;">DANGER</h1>			
FAILING TO FOLLOW SAFETY MESSAGES AND OPERATING INSTRUCTIONS CAN CAUSE SERIOUS BODILY INJURY OR EVEN DEATH TO OPERATOR AND OTHERS IN THE AREA.			
<p>1.</p> 	<p>2. NO RIDERS. NO CHILDREN OPERATORS.</p> 	<p>3. USE SAFETY SHOES, HARD HAT, SAFETY GLASSES, SEAT BELTS, & ROPS.</p> 	<p>4. BLOCK UP SECURELY BEFORE WORKING UNDER.</p> 
<p>1. Study and understand Operator's Manuals, Safety Signs, and Instructional Decals for tractor and implement to prevent misuse, abuse, and accidents. Practice before operating in a confined area or near passersby.</p> <ul style="list-style-type: none">● Learn how to stop engine suddenly in an emergency. Be alert for passersby and especially children. <p>2. Allow no children on or near implement or tractor. Allow no riders on tractor or implement. Falling off may cause serious injury or death from being run over by tractor or cutter or contact with rotating blades.</p> <p>3. Operate only with tractor having Roll-Over Protective Structure (ROPS) and with seatbelt fastened securely and snugly to prevent injury and possible death from falling off or tractor overturn. Personal Protective Equipment such as Hard Hat, Safety Glasses, Safety shoes, and Ear Plugs are recommended.</p> <p>4. Block up or support raised machine and all lifted components securely before putting hands or feet under or working underneath any lifted components to prevent crushing injury or death from sudden dropping or inadvertent operation of controls. Make certain area is clear before lowering or folding.</p> <p>5. Before transporting, put Lift Lever in detent or full-lift position. Install *Cylinder Stops as Transport Blocks securely on pull-type and folding implements. Slow down when turning and on hillsides.</p> <ul style="list-style-type: none">● Attach **Safety Chain to cutter and towing unit securely. See Operator's Manual. <p>6. Make certain that SMV sign, Warning Lights, and Reflectors are clearly visible. Follow local traffic codes.</p> <p>7. Never operate with Cutting Head raised if passersby, bystanders, or traffic are in the area to reduce possibility of injury or death from objects thrown by Blades under Guards or cutter structure.</p> <p>8. Before dismounting, secure implement in transport position or lower to ground.</p> <ul style="list-style-type: none">● Put tractor in park or set brake, disengage PTO, stop engine, and remove key, and wait until noise of rotation has ceased to prevent entanglement in rotating parts which can cause injury or death.● Never mount or dismount a moving vehicle. Crushing from runover may cause injury or death.			
<p>5. TRANSPORT SAFELY, LOCK UP.</p> 	<p>6. USE SMV, LIGHTS, & REFLECTORS.</p> 	<p>7. DO NOT OPERATE WITH CUTTER OR WING RAISED.</p> 	<p>8. DO NOT MOUNT OR DISMOUNT WHILE MOVING.</p> 

WARRANTY INFORMATION:

Read and understand the complete Warranty Statement found in this Manual. Fill out the Warranty Registration Form in full and return it to Alamo within 30 Days. Make certain the Serial Number of the Machine is recorded on the Warranty Card and on the Warranty Form that you retain.

TABLE OF CONTENTS

SAFETY SECTION	1-1
Safety Information	1-2thru6
Safety Decal Location	1-7
Safety Decals	1-8
INTRODUCTION SECTION	2-1
ASSEMBLY & OPERATION SECTION	3-1
Tractor Oil Flow Rates	3-2
Hydraulic Connections for Tractors w/ Open Center Hydraulics	3-2
PARTS SECTION	4-1

SAFETY SECTION

SAFETY

A safe and careful operator is the best operator. Safety is of primary importance to the manufacturer and should be to the owner/operator. Most accidents can be avoided by being aware of your equipment, your surroundings, and observing certain precautions. The first section of this manual includes a list of Safety Messages that, if followed, will help protect the operator and bystanders from injury or death. Read and understand these Safety Messages before assembling, operating or servicing this implement. This equipment should only be operated by those persons who have read the Manual, who are responsible and trained, and who know how to do so safely and responsibly.

The Safety Alert Symbol combined with a Signal Word, as seen below, is used throughout this manual and on decals which are attached to the equipment. The Safety Alert Symbol means: **“ATTENTION! BECOME ALERT! YOUR SAFETY IS INVOLVED!”** The Symbol and Signal Word are intended to warn the owner/operator of impending hazards and the degree of possible injury faced when operating this equipment..

Practice all usual and customary safe working precautions and above all---remember safety is up to YOU. Only YOU can prevent serious injury or death from unsafe practices.

CAUTION!

The lowest level of Safety Message; warns of possible injury. Decals located on the Equipment with this Signal Word are Black and Yellow.



WARNING!

Serious injury or possible death! Decals are Black and Orange.



DANGER!

Imminent death/critical injury. Decals are Red and White. (SG-1)



READ, UNDERSTAND, and FOLLOW the following Safety Messages. Serious injury or death may occur unless care is taken to follow the warnings and instructions stated in the Safety Messages. Always use good common sense to avoid hazards.

(SG-2)



SAFETY

PELIGRO!



Si no lee Ingles, pida ayuda a alguien que si lo lea para que le traduzca las medidas de seguridad. (SG-3)

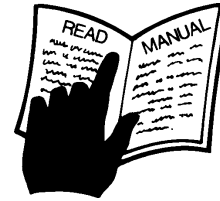

¡LEA EL INSTRUCTIVO!

DANGER!



Never operate the Tractor or Implement until you have read and completely understand this Manual, the Tractor Operator's Manual, and each of the Safety Messages found in the Manual or on the Tractor and Implement. Learn how to stop the tractor engine suddenly in an emergency. Never allow inexperienced or untrained personnel to operate the Tractor and Implement without supervision. Make sure the operator has fully read and understood the manuals prior to operation. (SG-4)

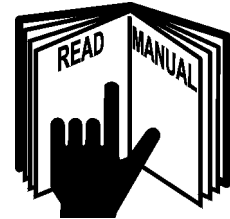

WARNING!



Always maintain the safety decals in good readable condition. If the decals are missing, damaged, or unreadable, obtain and install replacement decals immediately. (SG-5)

WARNING!



Make certain that the "Slow Moving Vehicle" (SMV) sign is installed in such a way as to be clearly visible and legible. When transporting the Equipment use the Tractor flashing warning lights and follow all local traffic regulations. (SG-6)

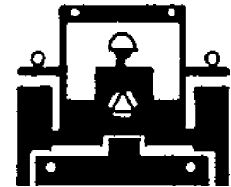

WARNING!



Operate this Equipment only with a Tractor equipped with an approved roll-over-protective system (ROPS). Always wear seat belts. Serious injury or even death could result from falling off the tractor--particularly during a turnover when the operator could be pinned under the ROPS. (SG-7)



WARNING!



Do not modify or alter this Implement. Do not permit anyone to modify or alter this Implement, any of its components or any Implement function. (SG-8)

DANGER!



BEFORE leaving the tractor seat, always engage the brake and/or set the tractor transmission in parking gear, disengage the PTO, stop the engine, remove the key, and wait for all moving parts to stop. Place the tractor shift lever into a low range or parking gear to prevent the tractor from rolling. Never dismount a Tractor that is moving or while the engine is running. Operate the Tractor controls from the tractor seat only. (SG-9)

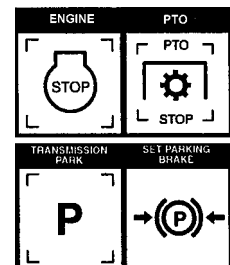

SAFETY

DANGER!



Never allow children or other persons to ride on the Tractor or Implement. Falling off can result in serious injury or death.

(SG-10)



DANGER!



Never allow children to operate or ride on the Tractor or Implement.

(SGM-11)



WARNING!



Do not mount the Tractor while the tractor is moving. Mount the Tractor only when the Tractor and all moving parts are completely stopped.

(SG-12)



DANGER!



Start tractor only when properly seated in the Tractor seat. Starting a tractor in gear can result in injury or death. Read the Tractor operators manual for proper starting instructions.

(SG-13)



DANGER!



Never work under the Implement, the framework, or any lifted component unless the Implement is securely supported or blocked up to prevent sudden or inadvertent falling which could cause serious injury or even death.

(SG-14)



DANGER!



Do not operate this Equipment with hydraulic oil leaking. Oil is expensive and its presence could present a hazard. Do not check for leaks with your hand! Use a piece of heavy paper or cardboard. High-pressure oil streams from breaks in the line could penetrate the skin and cause tissue damage including gangrene. If oil does penetrate the skin, have the injury treated immediately by a physician knowledgeable and skilled in this procedure.

(SG-15)



WARNING!



The operator and all support personnel should wear hard hats, safety shoes, safety glasses, and proper hearing protection at all times for protection from injury including injury from items thrown by the equipment.

(SG-16)

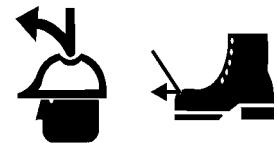

CAUTION!



PROLONGED EXPOSURE TO LOUD NOISE MAY CAUSE PERMANENT HEARING LOSS! Tractors with or without an Implement attached can often be noisy enough to cause permanent hearing loss. We recommend that you always wear hearing protection if the noise in the Operator's position exceeds 80db. Noise over 85db over an extended period of time will cause severe hearing loss. Noise over 90db adjacent to the Operator over an extended period of time will cause permanent or total hearing loss. *Note:* Hearing loss from loud noise [from tractors, chain saws, radios, and other such sources close to the ear] is cumulative over a lifetime without hope of natural recovery.

(SG-17)



SAFETY

WARNING!



Transport only at safe speeds. Serious accidents and injuries can result from operating this equipment at unsafe speeds. Understand the Tractor and Implement and how it handles before transporting on streets and highways. Make sure the Tractor steering and brakes are in good condition and operate properly.



Before transporting the Tractor and Implement, determine the safe transport speeds for you and the equipment. Make sure you abide by the following rules:

1. Test the tractor at a slow speed and increase the speed slowly. Apply the Brakes smoothly to determine the stopping characteristics of the Tractor and Implement. As you increase the speed of the Tractor the stopping distance increases. Determine the maximum safe transport speed for you and this Equipment.
2. Test the equipment at a slow speed in turns. Increase the speed through the turn only after you determine that it is safe to operate at a higher speed. Use extreme care and reduce your speed when turning sharply to prevent the tractor and implement from turning over. Determine the maximum safe turning speed for you and this equipment before operating on roads or uneven ground.
3. Only transport the Tractor and Implement at the speeds that you have determined are safe and which allow you to properly control the equipment.

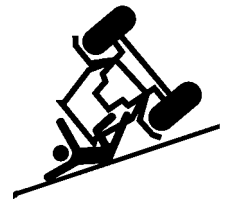

Be aware of the operating conditions. Do not operate the Tractor with weak or faulty brakes. When operating down a hill or on wet or rain slick roads, the braking distance increases: use extreme care and reduce your speed. When operating in traffic always use the Tractor's flashing warning lights and reduce your speed. Be aware of traffic around you and watch out for the other guy. (SG-19)

WARNING!



Never attempt to lubricate, adjust, or remove material from the Implement while it is in motion or while tractor engine is running. Make sure the tractor engine is off before working on the Implement.

(SG-20)

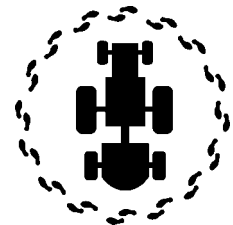

WARNING!



Periodically inspect all moving parts for wear and replace when necessary with authorized service parts. Look for loose fasteners, worn or broken parts, and leaky or loose fittings. Make sure all pins have cotter pins and washers. Serious injury may occur from not maintaining this machine in good working order. (SG-21)



WARNING!



Always read carefully and comply fully with the manufacturers instructions when handling oil, solvents, cleansers, and any other chemical agent. (SG-22)



DANGER!



Never run the tractor engine in a closed building or without adequate ventilation. The exhaust fumes can be hazardous to your health.

(SG-23)

SAFETY

DANGER!



Never allow children to play on or around Tractor or Implement. Children can slip or fall off the Equipment and be injured or killed. Children can cause the Implement to shift or fall crushing themselves or others. (SG-25)

DANGER!



NEVER use drugs or alcohol immediately before or while operating the Tractor and Implement. Drugs and alcohol will affect an operator's alertness and coordination and therefore affect the operator's ability to operate the equipment safely. Before operating the Tractor or Implement, an operator on prescription or over-the-counter medication must consult a medical professional regarding any side effects of the medication that would hinder their ability to operate the Equipment safely. **NEVER** knowingly allow anyone to operate this equipment when their alertness or coordination is impaired. Serious injury or death to the operator or others could result if the operator is under the influence of drugs or alcohol. (SG-27)

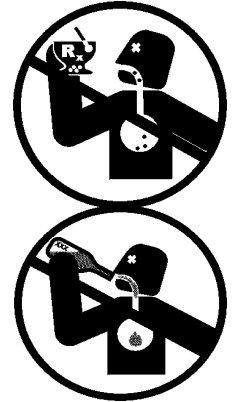

DANGER!



Operate the Tractor and/or Implement controls only while properly seated in the Tractor seat with the seat belt securely fastened around you. Inadvertent movement of the Tractor or Implement may cause serious injury or death. (SG-29)

WARNING!



Never leave Tractor and Implement unattended while the implement is in the lifted position. Accidental operation of lifting lever or a hydraulic failure may cause sudden drop of unit with injury or death by crushing. To properly park the implement when disconnecting it from the tractor, lower the stand and put the retaining pin securely in place, or put a secure support under the A-Frame. Lower the implement carefully to the ground. Do not put hands or feet under lifted components. (S3PT-1)

WARNING!



Be particularly careful when transporting the Implement with the Tractor. Turn curves or go up hills only at a low speed and using a gradual steering angle. Rear mounted implements move the center of gravity to the rear and remove weight from the front wheels. Make certain, by adding front ballast, that at least 20% of the tractor's weight is on the front wheels to prevent rearing up, loss of steering control or Tractor tip-over. Slow down on rough or uneven surfaces to prevent loss of steering control which could result in property damage or possible injury. Do not transport unless 3-Point lift lever is fully raised and in the latched transport position. Dropping implement in transport can cause serious damage to the tractor and/or Implement and possibly cause the operator or others to be injured or killed. (S3PT-2)

DANGER!



A rear Implement can fall if not properly supported. Always use the stand on the front hitch (if equipped) or block up securely to prevent falling and possible crushing injury and/or other injury from holding or lifting heavy components. Use the stand to stabilize the implement during storage. (S3PT-3)

DANGER!



There are obvious and hidden potential hazards in the operation of this Blower. **REMEMBER!** The Blower can throw objects for 25 yards. Serious injury or even death may occur unless care is taken to insure the safety of the operator, bystanders, or passersby in the area. Do not operate this machine with anyone in the immediate area. Stop blowing if anyone is within 25 yards of machine. (SBW-1)

SAFETY

In addition to the design and configuration of this Implement, including Safety Signs and Safety Equipment, hazard control and accident prevention are dependent upon the awareness, concern, prudence, and proper training of personnel involved in the operation, transport, maintenance, and storage of the machine. Refer also to Safety Messages and operation instruction in each of the appropriate sections of the Tractor and Equipment Manuals. Pay close attention to the Safety Signs affixed to the Tractor and Equipment. (SG-18)

PARTS INFORMATION

Alamo Industrial mowers use balanced and matched system components for blade carriers, blades, cuttershafts, knives, knife hangers, rollers, drivetrain components, and bearings. These parts are made and tested to Alamo Industrial specifications. Non-genuine "will fit" parts do not consistently meet these specifications. The use of "will fit" parts may reduce mower performance, void mower warranties, and present a safety hazard. Use genuine Alamo Industrial mower parts for economy and safety. (SPAM-1)

SEE YOUR ALAMO DEALER

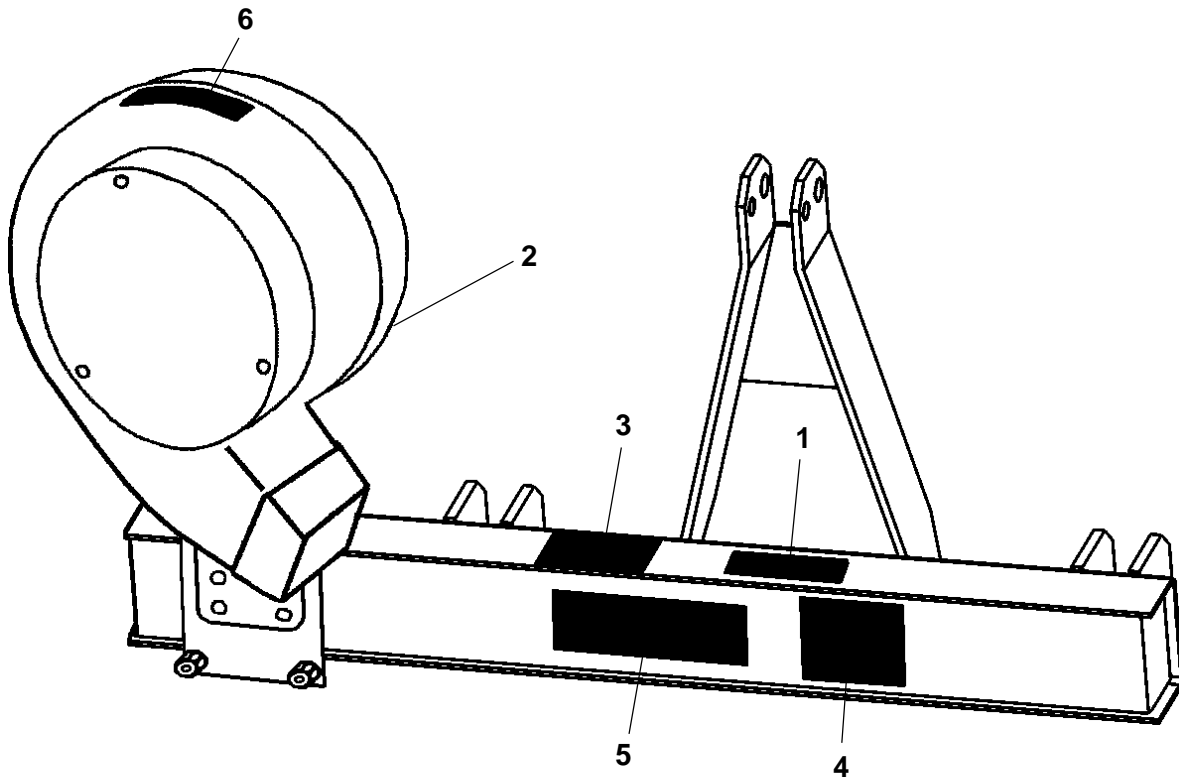

ITEM	PART NO.	QTY	DESCRIPTION
1	00725746	1	Decal - Spanish Translation
2	00756049	1	Decal - Warning Leaking Oil
3	02925100	1	Decal - Replacement Parts
4	02960766	1	Decal - Alamo Group (Logo)
5	02974764	1	Decal - Blow Gun (Name)
6	02974765	1	Decal - Missing Shield

SAFETY

PELIGRO

Si No Lee Ingles, Pida Ayuda a Alguien Que Si Lo Lea Para Que le Traduzca las Medidas de Seguridad.

LEA EL INSTRUCTIVO



00725746

1 - 00725746

IMPORTANT

For your safety and to guarantee optimum product reliability, always use Genuine ALAMO INDUSTRIAL replacement parts. The use of inferior "will-fit" parts will void Warranty of your ALAMO INDUSTRIAL implement and may cause premature or catastrophic failure which can result in serious injury or death. If you have any questions concerning the repair parts you are using, contact ALAMO INDUSTRIAL, 1502 E. Walnut Seguin, TX 78155 (830) 372-3651.



3 - 02925100



4 - 02960766

WARNING

USE PAPER OR CARDBOARD TO CHECK FOR LEAKS. **NEVER USE YOUR HAND.** IF OIL PENETRATES SKIN, GANGRENE OR OTHER SERIOUS INJURY COULD OCCUR. **GET IMMEDIATE MEDICAL ATTENTION.** See Operator's Manual.



00756059

2 - 00756059

BlowGun™

5 - 02974764

WARNING

FAILURE TO USE AND MAINTAIN SHIELDS AND DEFLECTORS IN GOOD CONDITION MAY LEAD TO INJURY OR DEATH FROM ENTANGLEMENT WITH ROTATING PARTS, BEING HIT BY OBJECTS THROWN WITH GREAT FORCE BY BLADES, OR BY BLADE CONTACT.

Always replace Guards which have been removed for maintenance. Never operate with Guards missing or broken.

02974765

6 - 02974765

INTRODUCTION SECTION

INTRODUCTION

This Debris Blower is designed with care and built with quality materials by skilled workers. Proper assembly, maintenance, and operating practices, as described in this manual, will help the owner/operator get years of satisfactory service from the machine.

The purpose of this manual is to familiarize, and instruct. The Assembly & Operation Section has important information that BlowGun operators need to know. The Parts Listing section is designed to familiarize the owner/operator with replaceable parts on the BlowGun. This section provides exploded assembly drawings of each mower component illustrating each piece and the corresponding part number.

Careful use and timely service saves extensive repairs and costly downtime losses. Safety is of primary importance to the owner/operator and to the manufacturer. The first section of this manual includes a list of Safety Messages, that, if followed, will help protect the operator and bystanders from injury or death. Many of the Safety Messages will be repeated throughout the manual. The owner/operator/dealer should know these Safety Messages before assembly and be aware of the hazards of operating this mower during assembly, use, and maintenance. The Safety Alert Symbol combined with a Signal Word, as seen below, is intended to warn the owner/operator of impending hazards and the degree of possible injury faced when operating this machine.

CAUTION The lowest level of Safety Message; warns of possible minor injury. Decals located on the Mower with this Signal Word are Black and Yellow.



WARNING Serious injury or possible death! Decals are Black and Orange.



DANGER Imminent death/critical injury. Decals are Red and White.



INTRODUCTION



WARNING



At least 20% of the tractor's total weight must be on the front tires with the Mower lifted to provide adequate traction for safe steering under good conditions. Slow down on hills, rough terrain, and curves.

Front and rear, and left and right are determined by the normal direction of travel (the same as on your automobile).

INTRODUCTION

ATTENTION OWNER/OPERATOR

BEFORE OPERATING THIS MACHINE:

1. Carefully read the Operator's Manual, completely understand the Safety Messages and instructions, and know how to operate correctly both the tractor and Debris Blower.
2. Fill out the Warranty Card in full. Be sure to answer all questions, including the Serial Number of the Debris Blower. Mail within 30 days of delivery date of this implement.

NOTE: *Warranties are honored only if completed "Owner Registration and Warranty" forms are received by Alamo Group within thirty days of delivery of the mower.*

3. Record the BlowGun Model and Serial Numbers on the Warranty page at the front of the Operator's Manual. Keep this as part of the permanent maintenance file for the BlowGun.

IMPORTANT

For your safety and to guarantee optimum product reliability, always use Genuine ALAMO INDUSTRIAL replacement parts. The use of inferior "will-fit" parts will void Warranty of your ALAMO INDUSTRIAL implement and may cause premature or catastrophic failure which can result in serious injury or death. If you have any questions concerning the repair parts you are using, contact ALAMO INDUSTRIAL, 1502 E. Walnut Seguin, TX 78155 (830) 372-3551.



ASSEMBLY & OPERATION SECTION

ASSEMBLY & OPERATION

The height to the center of the BlowGun from the ground should be approximately 26 inches while the angle is decided by operation experimentation.

These settings are recommendations for general mowing operations. It is permissible to vary the mounting positions should special individual conditions require it.

TRACTOR OIL FLOW RATES

Tractors with a closed center hydraulic system or with an oil flow capability of less than 9.5 GPM should be fitted with the low flow BlowGun. For those with a flow capacity of 9.5 GPM and above the high flow BlowGun should be fitted.

Working a high flow BlowGun on a low flow tractor will result in considerably reduced blower performance.

Working a low flow BlowGun on a high flow tractor will result in the same degree of blower performance but the oil will overheat.

HYDRAULIC CONNECTIONS FOR TRACTORS WITH OPEN CENTER HYDRAULICS

The pressure supply hose is taken from the tractor's single acting auxiliary service (remote hydraulic QD coupler) and connected to the flow control valve block opposite the hexagon head of the valve as shown in Figure 1.

The return hose from the motor is connected to the tractor's zero back-pressure or return to reservoir port. Contact your dealer and/or tractor manual for correct procedure for individual tractors. **NOTE:** Where oil is returned to the transmission casing it may be necessary to extend the return hose.

WARNING! Connecting the return hose to a tractor's double acting spool can result in a blown shaft seal due to back pressure caused by the fan over-run and restricted return line.



Engagement of the BlowGun is by auxiliary control (remote hydraulics) lever.

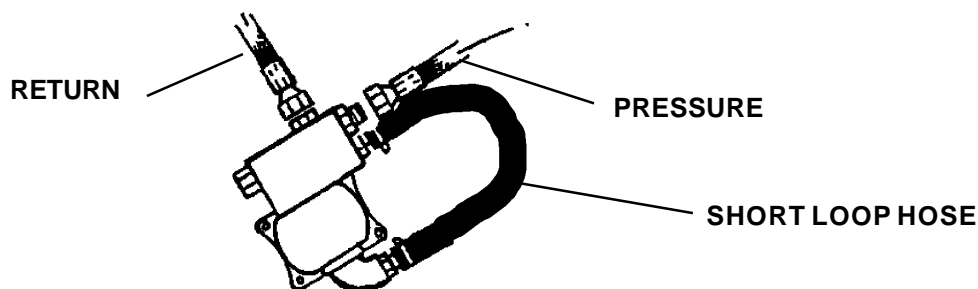

Figure 1

ASSEMBLY & OPERATION

HYDRAULIC CONNECTIONS FOR TRACTORS WITH CLOSED CENTER HYDRAULICS

Where tractors have closed center hydraulics, the following modifications are required: The return hose, the short loop hose and their connections are removed from the flow control block. The ports should be blanked using the plugs provided and pipe thread sealant.

Replace the low pressure connectors from the cast elbow on the return side of the motor with the hydraulic connectors taken from the return port of the block. The return hose is then connected to these fittings as shown in Figure 2. The hoses are then connected to the tractor as described in the above section for hydraulic connections for tractors with open center hydraulics.

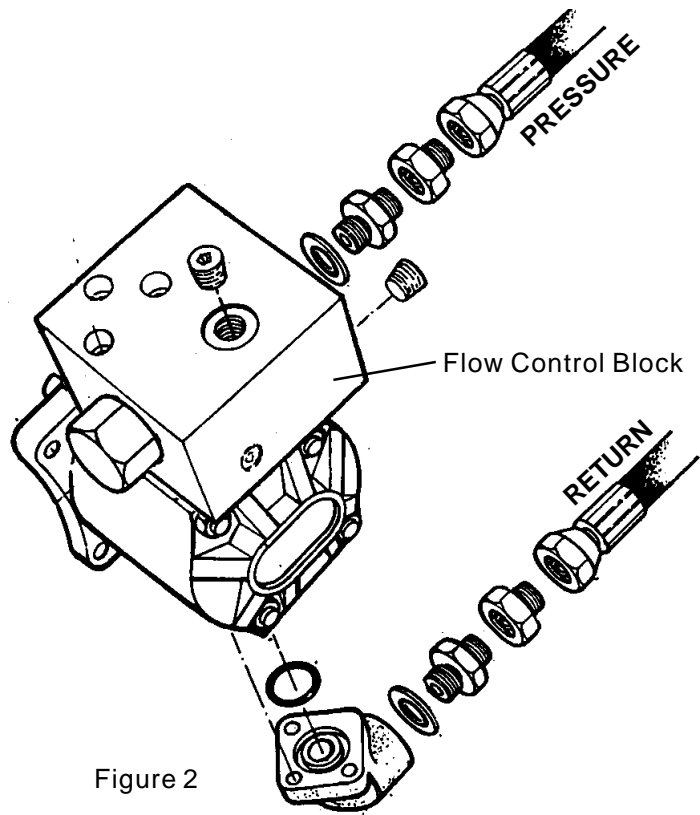

Figure 2

PARTS SECTION

PARTS ORDERING GUIDE

The following instructions are offered to help eliminate needless delay and error in processing purchase orders for the equipment in this section.

1. The Parts Section is prepared in logical sequence and grouping of parts that belong to the basic machine featured in this manual. Part Numbers and Descriptions are given to help locate the parts and quantities required.
2. The Purchase Order must include the name and address of the person or organization ordering the parts, who should be charged, and if possible, the serial number of the machine for which the parts are ordered.
3. The Purchase Order must clearly list the quantity of each part, the complete and correct part number, and the basic name of the part.
4. The Manufacturer reserves the right to substitute parts where applicable.
5. Some parts are unlisted items which are special production items not normally stocked and are subject to special handling. Request a quotation for such parts before sending a Purchase Order.
6. The Manufacturer reserves the right to change prices without prior notice.

NOTE: Please refer to The Safety Section in the front of this Manual for the proper Part Number when ordering Replacement Safety Decals.



For maximum safety and to guarantee optimum product reliability, always use genuine Alamo Group Parts. The use of inferior replacement parts may cause premature or catastrophic failure which could result in serious injury or death. Direct any questions regarding parts to:



Alamo Industrial
1502 E. Walnut
Seguin, Texas 78155
830-372-3551

PARTS TABLE OF CONTENTS

Radial Wheel & Motor	4-2&3
Casing & Mounting	4-4
Blower to Mount Assembly	4-5

RADIAL WHEEL & MOTOR

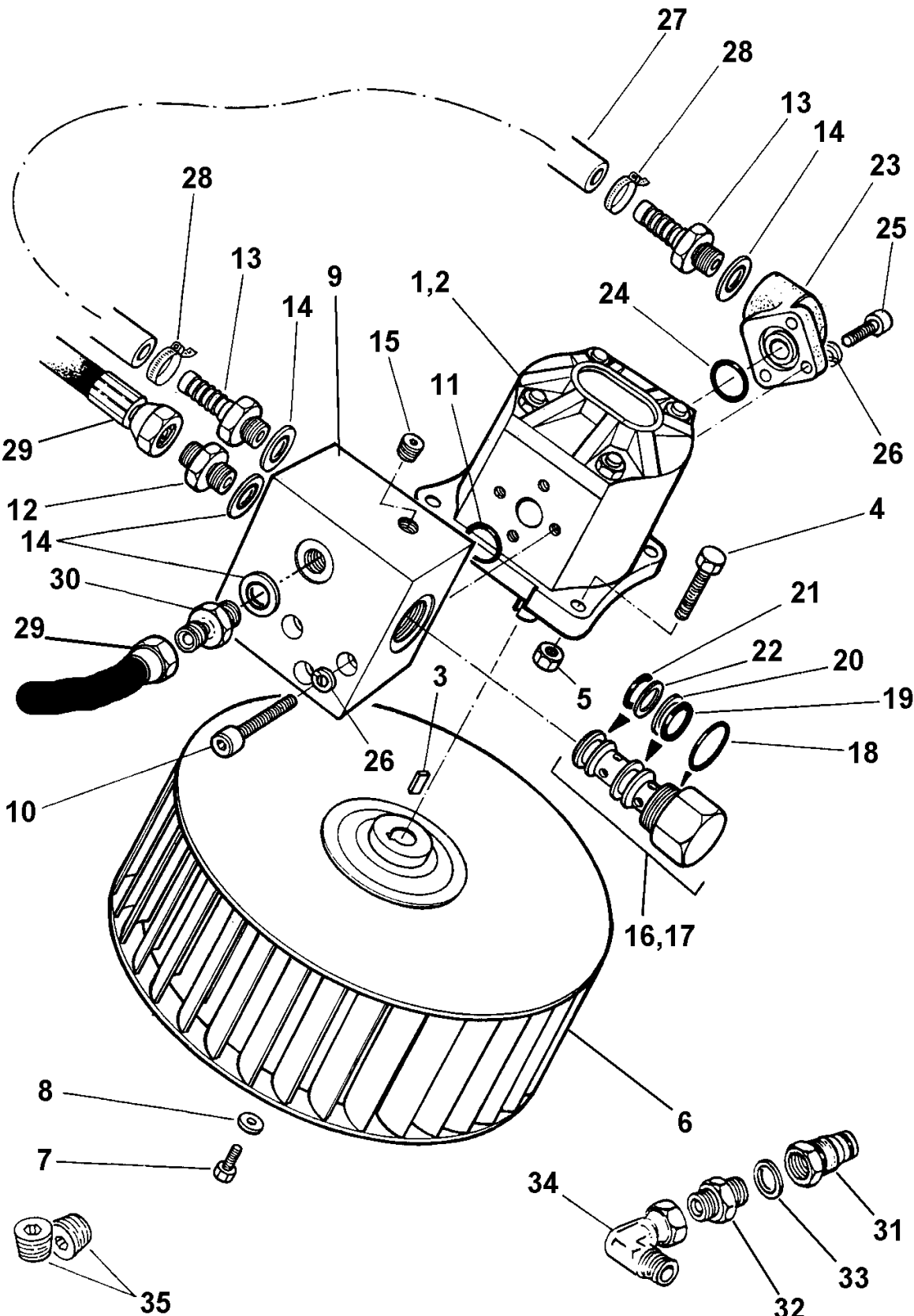

RADIAL WHEEL & MOTOR

ITEM	PART NO.	QTY	DESCRIPTION
Motor & Radial Wheel for T.I. M/CS w/ Open Center Hydraulics			
1	83 01 286	1	Hydraulic Motor - Low Flow
2	83 01 285	1	Hydraulic Motor - High Flow
3	82 01 161	1	Key
4	92 13 084	4	Bolt
5	91 43 004	4	Self-Locking Nut
6	73 19 008	1	Radial Wheel
7	93 13 003	1	Setscrew
8	73 19 013	1	Special Washer
9	81 32 255	1	Flow Control Block
10	93 43 104	3	Cap Screw Socket Head
11	86 00 402	1	O-Ring
12	G5200700	1	Union
13	80 02 059	2	Adapter
14	86 50 104	4	Bonded Seal
15	85 82 043	1	Taper Plug
16	81 04 040	1	Flow Control Valve Assy - High Flow
17	81 04 041	1	Flow Control Valve Assy - Low Flow
18	86 00 716	1	O-Ring
19	87 00 775	1	O-Ring
20	87 09 775	1	Anti-Extrusion Ring
21	87 00 772	1	O-Ring
22	87 09 772	1	Anti-Extrusion Ring
23	83 01 027	1	Return Elbow
24	86 00 403	1	O-Ring
25	93 43 054	3	Cap Screw Socket Head
26	91 00 204	5	Spring Washer
27	85 01 059	1	Hose
28	09 04 204	2	Hose Clip
29	02974458	2	Hose
30	8581271	1	Adapter
	86 99 242	-	Seal Kit for Hydraulic Motor
KIT FOR S.I. INSTALLATION			
31	81 30 180	1	Pressure Carry Over
32	60 00 112	1	Union
33	86 50 103	1	Bonded Seal
34	85 81 215	1	Swivel Elbow
KIT FOR CLOSED CIRCUIT HYDRAULICS			
35	81 03 001	2	Taper Plug

CASING & MOUNTING

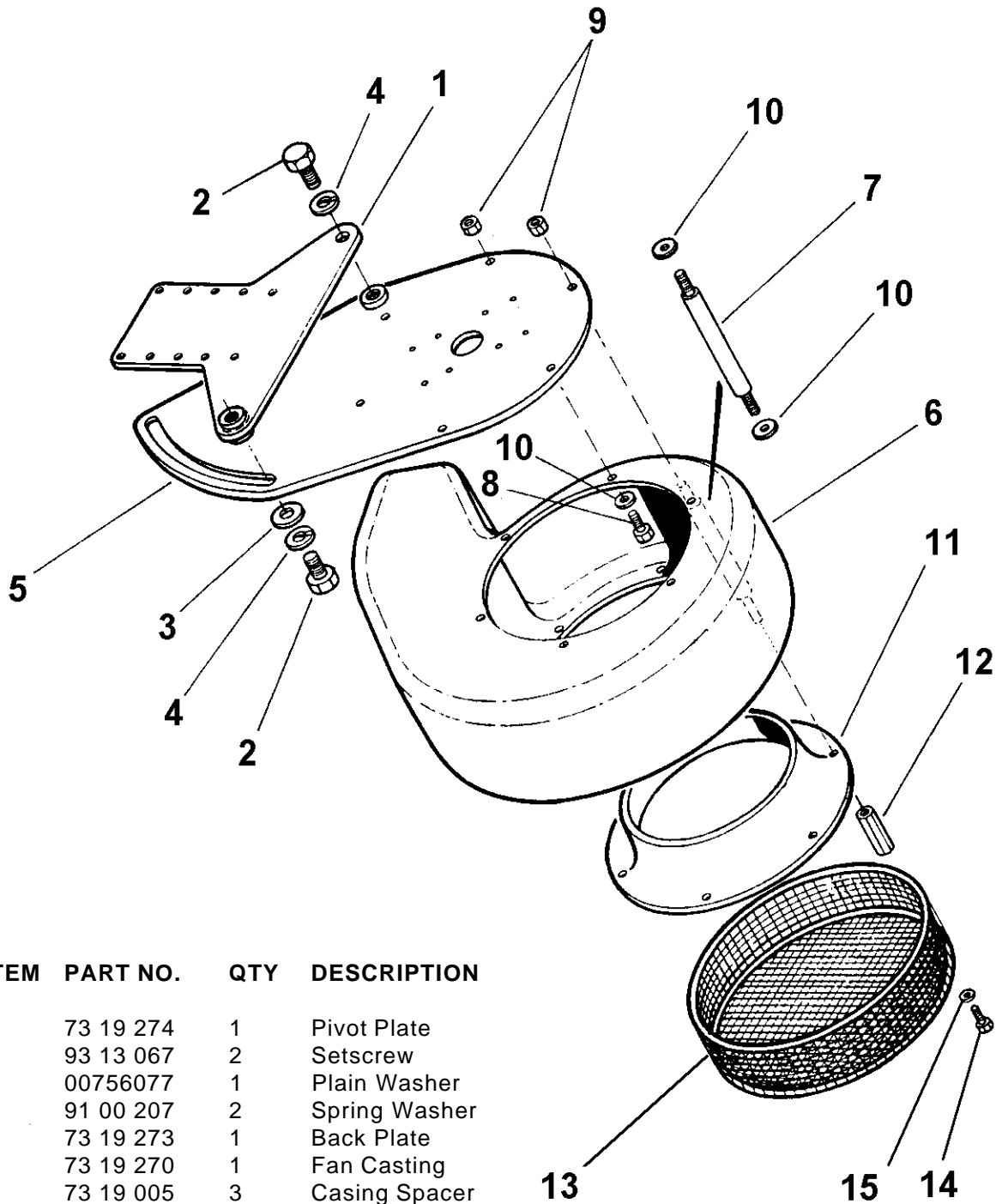

ITEM	PART NO.	QTY	DESCRIPTION
1	73 19 274	1	Pivot Plate
2	93 13 067	2	Setscrew
3	00756077	1	Plain Washer
4	91 00 207	2	Spring Washer
5	73 19 273	1	Back Plate
6	73 19 270	1	Fan Casting
7	73 19 005	3	Casing Spacer
8	93 13 054	3	Setscrew
9	91 43 004	6	Self-Locking Nut
10	91 00 104	6	Plain Washer
11	73 19 271	1	Shroud
12	73 19 004	3	Guard Spacer
13	73 19 272	1	Guard
14	93 83 043	3	Setscrew Panhead
15	91 00 103	3	Plain Washer

BLOWER TO MOUNT ASSEMBLY

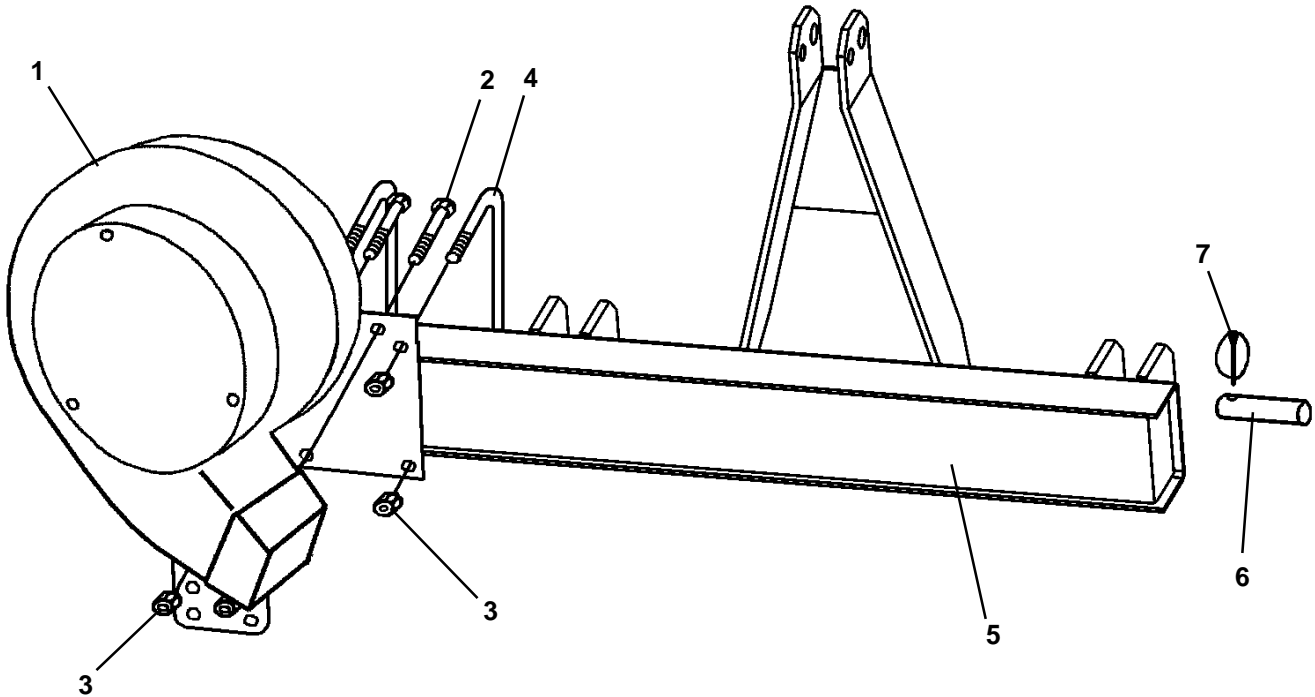

ITEM	PART NO.	QTY	DESCRIPTION
1	7319261	1	Assembly Blower - RH High Flow
	7319260	1	Assembly Blower - LH Low Flow
2	00748823	2	Bolt
3	00001800	6	Nut
4	02974286	2	U-Bolt
5	02974478	1	Mount Weldment
6	4410212A	2	Pin, Wrist
7	2196	2	Clip, Lynch Pin

ALAMO INDUSTRIAL

LIMITED WARRANTY

1. LIMITED WARRANTIES

- 1.01. Alamo Industrial warrants for one year from the purchase date to the original non-commercial, governmental, or municipal purchaser ("Purchaser") and warrants for six months to the original commercial or industrial purchaser ("Purchaser") that the goods purchased are free from defects in material or workmanship.
- 1.02. Manufacturer will replace for the Purchaser any part or parts found, upon examination at one of its factories, to be defective under normal use and service due to defects in material or workmanship.
- 1.03. This limited warranty does not apply to any part of the goods which has been subjected to improper or abnormal use, negligence, alteration, modification, or accident, damaged due to lack of maintenance or use of wrong fuel, oil, or lubricants, or which has served its normal life. This limited warranty does not apply to any part of any internal combustion engine, or expendable items such as blades, shields, guards, or pneumatic tires except as specifically found in your Operator's Manual.
- 1.04. Except as provided herein, no employee, agent, Dealer, or other person is authorized to give any warranties of any nature on behalf of Manufacturer.

2. REMEDIES AND PROCEDURES.

- 2.01. This limited warranty is not effective unless the Purchaser returns the Registration and Warranty Form to Manufacturer within 30 days of purchase.
- 2.02. Purchaser claims must be made in writing to the Authorized Dealer ("Dealer") from whom Purchaser purchased the goods or an approved Authorized Dealer ("Dealer") within 30 days after Purchaser learns of the facts on which the claim is based.
- 2.03. Purchaser is responsible for returning the goods in question to the Dealer.
- 2.04. If after examining the goods and/or parts in question, Manufacturer finds them to be defective under normal use and service due to defects in material or workmanship, Manufacturer will:
 - (a) Repair or replace the defective goods or part(s) or
 - (b) Reimburse Purchaser for the cost of the part(s) and reasonable labor charges (as determined by Manufacturer) if Purchaser paid for the repair and/or replacement prior to the final determination of applicability of the warranty by Manufacturer.

The choice of remedy shall belong to Manufacturer.

- 2.05. Purchaser is responsible for any labor charges exceeding a reasonable amount as determined by Manufacturer and for returning the goods to the Dealer, whether or not the claim is approved. Purchaser is responsible for the transportation cost for the goods or part(s) from the Dealer to the designated factory.

3. LIMITATION OF LIABILITY.

- 3.01. MANUFACTURER DISCLAIMS ANY EXPRESS (EXCEPT AS SET FORTH HEREIN) AND IMPLIED WARRANTIES WITH RESPECT TO THE GOODS INCLUDING, BUT NOT LIMITED TO, MERCHANTABILITY AND FITNESS FOR A PARTICULAR PURPOSE.
- 3.02. MANUFACTURER MAKES NO WARRANTY AS TO THE DESIGN, CAPABILITY, CAPACITY, OR SUITABILITY FOR USE OF THE GOODS.
- 3.03. EXCEPT AS PROVIDED HEREIN, MANUFACTURER SHALL HAVE NO LIABILITY OR RESPONSIBILITY TO PURCHASER OR ANY OTHER PERSON OR ENTITY WITH RESPECT TO ANY LIABILITY, LOSS, OR DAMAGE CAUSED OR ALLEGED TO BE CAUSED DIRECTLY OR INDIRECTLY BY THE GOODS INCLUDING, BUT NOT LIMITED TO, ANY INDIRECT, SPECIAL, CONSEQUENTIAL, OR INCIDENTAL DAMAGES RESULTING FROM THE USE OR OPERATION OF THE GOODS OR ANY BREACH OF THIS WARRANTY. NOT WITHSTANDING THE ABOVE LIMITATIONS AND WARRANTIES, MANUFACTURER'S LIABILITY HEREUNDER FOR DAMAGES INCURRED BY PURCHASER OR OTHERS SHALL NOT EXCEED THE PRICE OF THE GOODS.
- 3.04. NO ACTION ARISING OUT OF ANY CLAIMED BREACH OF THIS WARRANTY OR TRANSACTIONS UNDER THIS WARRANTY MAY BE BROUGHT MORE THAN TWO (2) YEARS AFTER THE CAUSE OF ACTION HAS OCCURRED.

4. MISCELLANEOUS.

- 4.01. Proper Venue for any lawsuits arising from or related to this limited warranty shall be only in Guadalupe County, Texas.
- 4.02. Manufacturer may waive compliance with any of the terms of this limited warranty, but no waiver of any terms shall be deemed to be a waiver of any other term.
- 4.03. If any provision of this limited warranty shall violate any applicable law and is held to be unenforceable, then the invalidity of such provision shall not invalidate any other provisions herein.
- 4.04. Applicable law may provide rights and benefits to purchaser in addition to those provided herein.

KEEP FOR YOUR RECORDS

ATTENTION: Purchaser should fill in the blanks below for his reference when buying repair parts and/or for proper machine identification when applying for warranty.

Alamo Industrial Implement Model _____ Serial Number _____

Date Purchased _____ Dealer _____

ATTENTION:
READ YOUR OPERATOR'S MANUAL

ALAMO INDUSTRIAL

An Alamo Group Company
Post Office Drawer 549
Seguin, Texas 78156
830-379-1480





TO THE OWNER/OPERATOR/DEALER

To keep your implement running efficiently and safely, read your manual thoroughly and follow these directions and the Safety Messages in this Manual. The Table of Contents clearly identifies each section where you can easily find the information you need.

The OCCUPATIONAL SAFETY AND HEALTH ACT (1928.51 Subpart C) makes these minimum safety requirements of tractor operators:

REQUIRED OF THE OWNER:

1. Provide a Roll-Over-Protective Structure that meets the requirements of this Standard; and
2. Provide Seatbelts that meet the requirements of this paragraph of this Standard and SAE J4C; and
3. Ensure that each employee uses such Seatbelt while the tractor is moving; and
4. Ensure that each employee tightens the Seatbelt sufficiently to confine the employee to the protected area provided by the ROPS.

REQUIRED OF THE OPERATOR

1. Securely fasten seatbelt if the tractor has a ROPS.
2. Where possible, avoid operating the tractor near ditches, embankments, and holes.
3. Reduce speed when turning, crossing slopes, and on rough, slick, or muddy surfaces.
4. Stay off slopes too steep for safe operation.
5. Watch where you are going - especially at row ends, on roads, and around trees.
6. Do not permit others to ride.
7. Operate the tractor smoothly - no jerky turns, starts, or stops.
8. Hitch only to the drawbar and hitch points recommended by the tractor manufacturer.
9. When the tractor is stopped, set brakes securely and use park lock, if available.

Keep children away from danger all day, every day...

Equip tractors with rollover protection (ROPS) and keep all machinery guards in place...

Please work, drive, play and live each day with care and concern for your safety and that of your family and fellow citizens.

